























Monteringsvejledning – Model Loke



| | |
|------------------------|--------------|
| PRODUCT NAME _____ | MODERN _____ |
| REFERENCE NUMBER _____ | |

| No. | Dimensions (mm) | | | Quantity | Image | Part name/ Use for |
|-----|-----------------|-----|----|----------|---|----------------------|
| | | | | | | |
| 1 | 3000 | 110 | 28 | 18 |  | Wall A B |
| 2 | 3000 | 55 | 28 | 2 |  | Wall A B |
| 3 | 3000 | 110 | 28 | 1 |  | Wall A |
| 4 | 2000 | 110 | 28 | 36 |  | Wall C D |
| 5 | 496 | 110 | 28 | 21 |  | Wall A |
| 6 | 388 | 110 | 28 | 4 |  | Wall A |
| 7 | 1644 | 110 | 28 | 13 |  | Wall A |
| 8 | 3200 | 110 | 28 | 2 |  | Wall A B |
| 9 | 3200 | 130 | 43 | 1 |  | Rafter |
| 10 | 2220 | 110 | 20 | 30 |  | Roof boards |
| 11 | 1775 | 110 | 20 | 26 |  | Floor boards |
| 12 | 2220 | 105 | 20 | 2 |  | Wind boards |
| 13 | 3244 | 105 | 20 | 2 |  | Wind boards |
| 14 | 2220 | 60 | 16 | 2 |  | Wind board supporter |
| 15 | 3200 | 35 | 25 | 2 |  | Roof plank |
| 16 | 1784 | 35 | 25 | 2 |  | Floor trim |
| 17 | 2784 | 35 | 25 | 2 |  | Floor trim |
| 18 | 2840 | 55 | 35 | 5 |  | Bearers |
| 19 | 2100 | 220 | 28 | 2 |  | Roof frame triangle |
| 20 | 1870 | 850 | 28 | 1 |  | Door |
| 21 | 410 | 750 | 28 | 1 |  | Window |

| Screws | | | Nails | | |
|---|-------|---------------------------|---|-------|------------|
|  | 3.5x5 | For windows and doors |  | 2.5x6 | For boards |
|  | 3.5x3 | For roof decorative parts | | | |

IMPORTANT (Read carefully before starting)!

- The following instructions include both pictures (indicating every part by the digits – see part list above) and illustrations. Please keep in mind that the illustrations are just a general guide to assembling all our products (For example: The illustration on how to assemble a roof applies to all our roofs). However specific models will vary in the quantity of materials needed. By closely consulting the part-list, you will know how many parts you need for each stage of the assembly, while the illustrations will show you how put them together.

- If some extra boards are left over after assembling your product, do not worry. We sometimes include extra boards to ensure that the delivery package is perfectly compact and solid.

1. General instructions

Read carefully before starting. First of all, we want to thank you for buying one of our products. Please read these instructions carefully before unpacking the parts.

2. Storing your product prior to assembly.

Your unpacked product must be stored in a dry, ventilated place, where it is protected from the weather (the package is not waterproof) and direct sunlight. The package and parts should be laid flat on the ground in order to avoid any damage to them. We strongly recommend assembling the product as soon as possible after it is delivered, because any complaints regarding missing or damaged parts can only be made up to 10 days after the date of delivery.

3. Safety.

The wooden parts may cause splinters, so please handle them carefully and wear protective gloves. Make sure there are no protruding nails, screws or staples in the assembled pieces. Always follow the instructions carefully and keep to the order of steps.

4. Assembly.

Before starting to assemble your structure, we strongly recommend that you watch our video guide on our website www.quick-garden.co.uk (under the category "Assembly"). During the installation process constantly check that everything is level and parallel. For all parts that need to be assembled using screws, it is advisable to pre-drill holes to avoid the risk of splitting the wood during screwing.

4.1. Familiarize yourself with the parts. All parts are numbered, so start by checking that all parts are present by matching them off against your instruction manual. We recommend you sort the parts into separate piles. You will need a rubber hammer, electric screw-driver and anchor screws.

4.2. Foundation. Before starting the installation, make sure that the building surface is perfectly flat and level. Lay the foundation elements (PVC blocks, concrete slabs, etc.) For floorless models, the foundation should be at least the same size or larger (recommended) than the external dimension of the structure.

4.3. Bearers. The bearers must be placed according to the picture below (general sample) with gaps of around 50 cm between each other. Screw the bearers into the foundation with anchor screws.

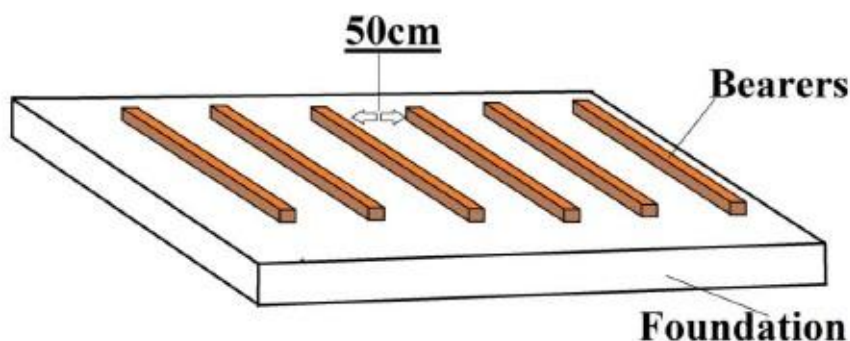

The actual bearers' plan:

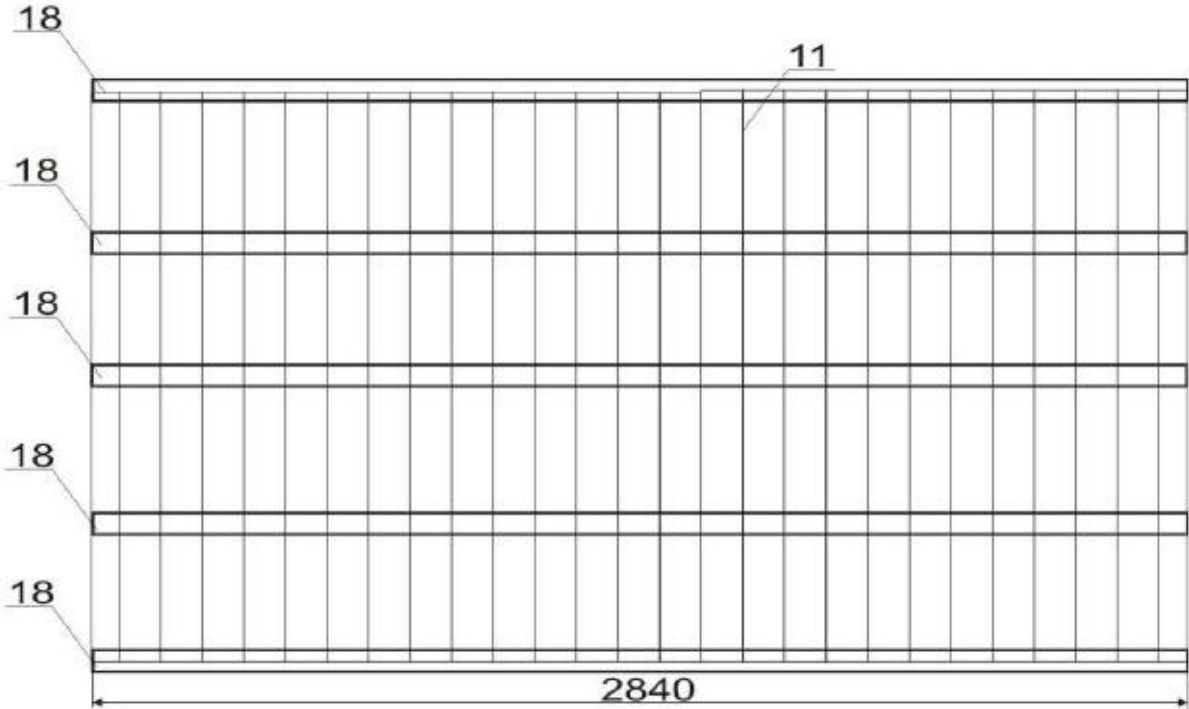

4.4. Assembling the walls: place the wall-boards on the bearers as shown in a general sample below:

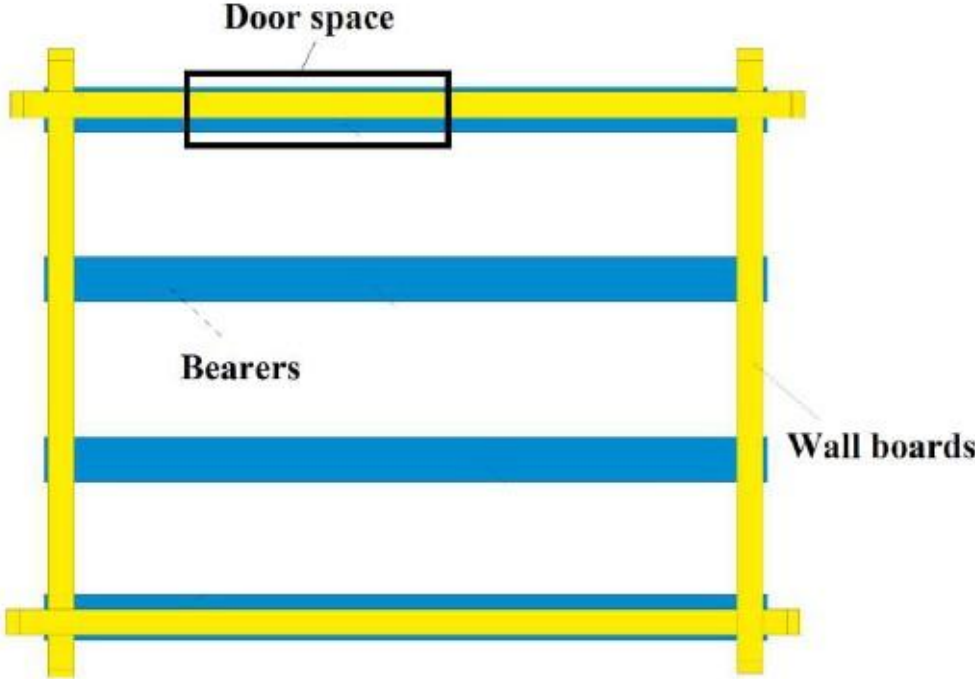

The actual walls' plan:

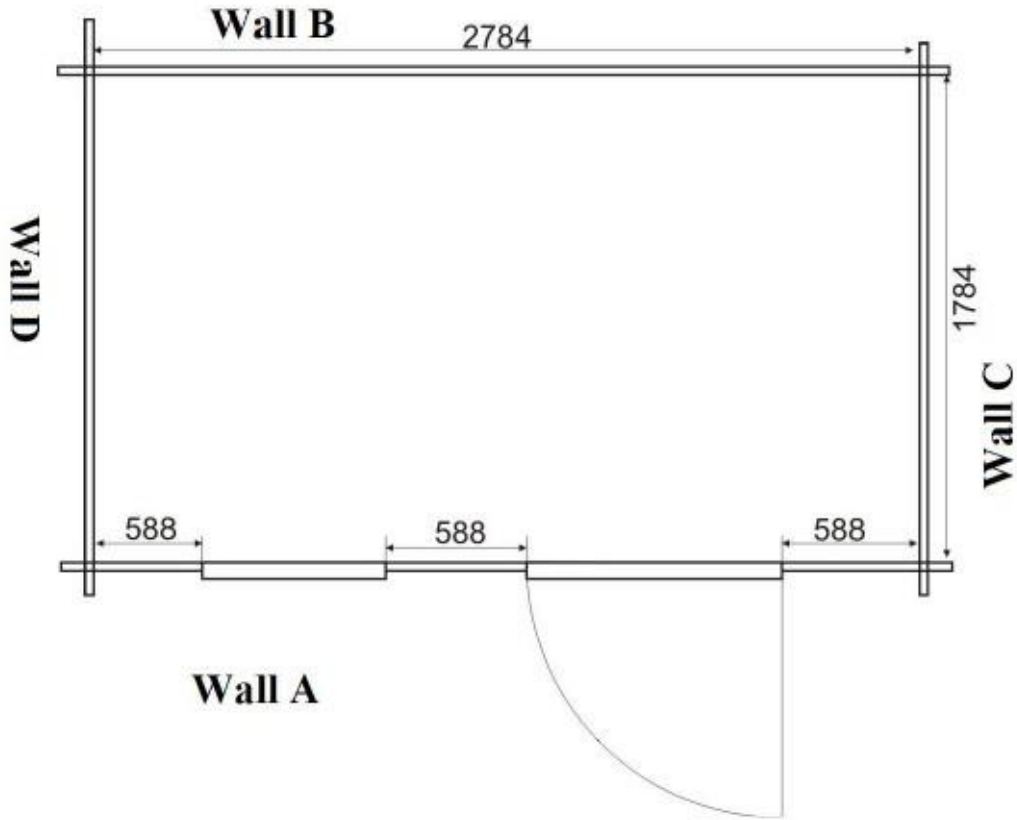

The wall-boards must be placed so that the ends interlock. Now screw the first row of wall-boards into the bearers. All the following rows of placed wall-boards should interlock not only at the ends, but along their length as well. Please screw each new row of wall-boards into the former row to ensure a solid structure.

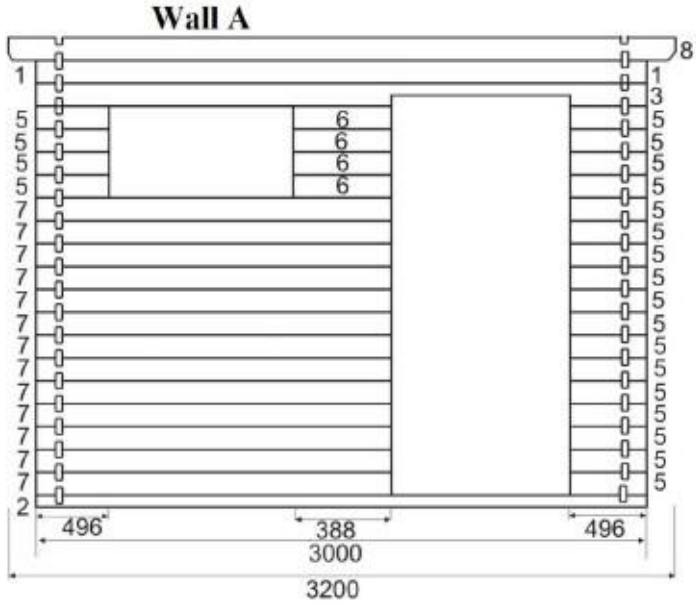

Wall B

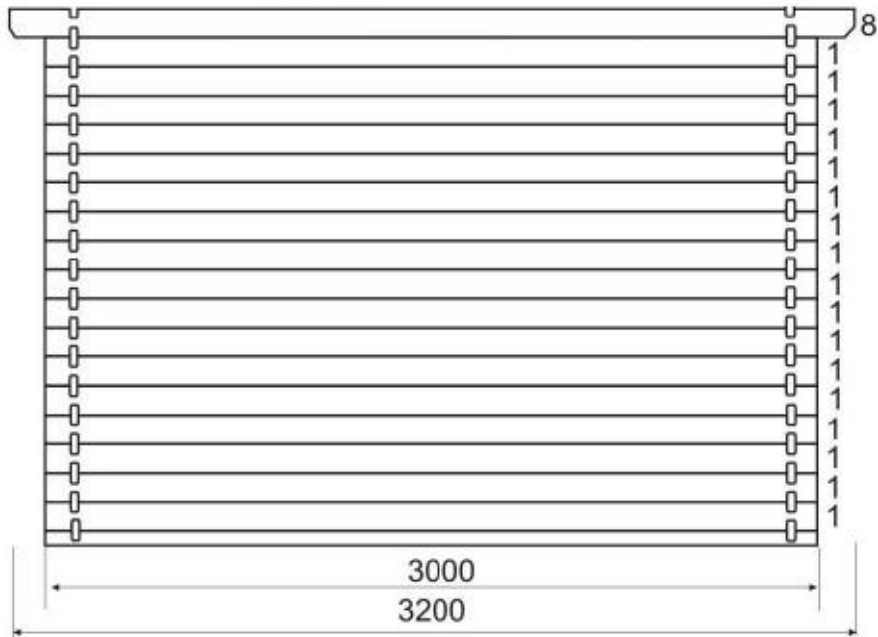

Wall C

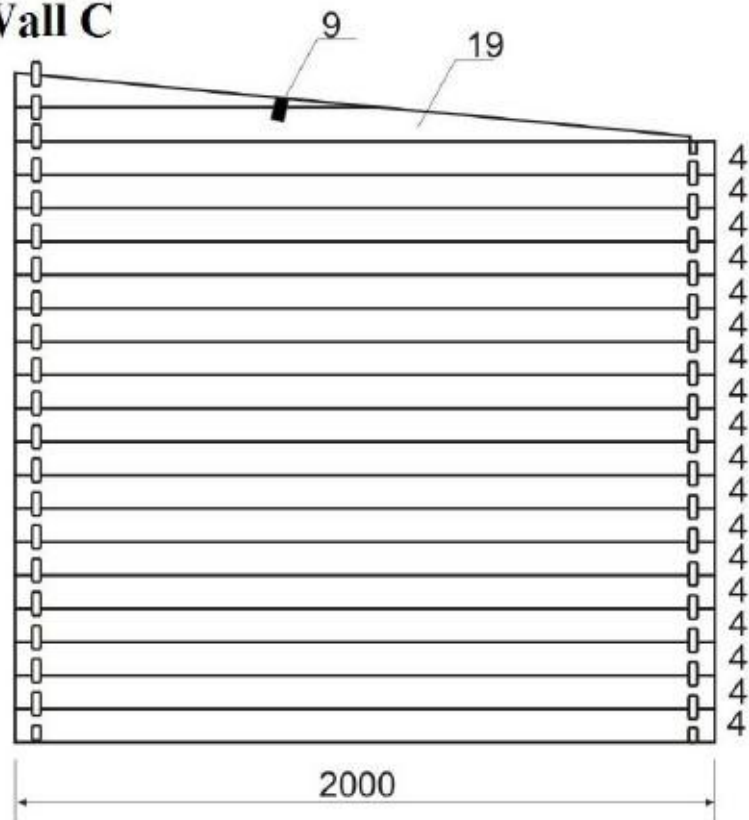

Wall D

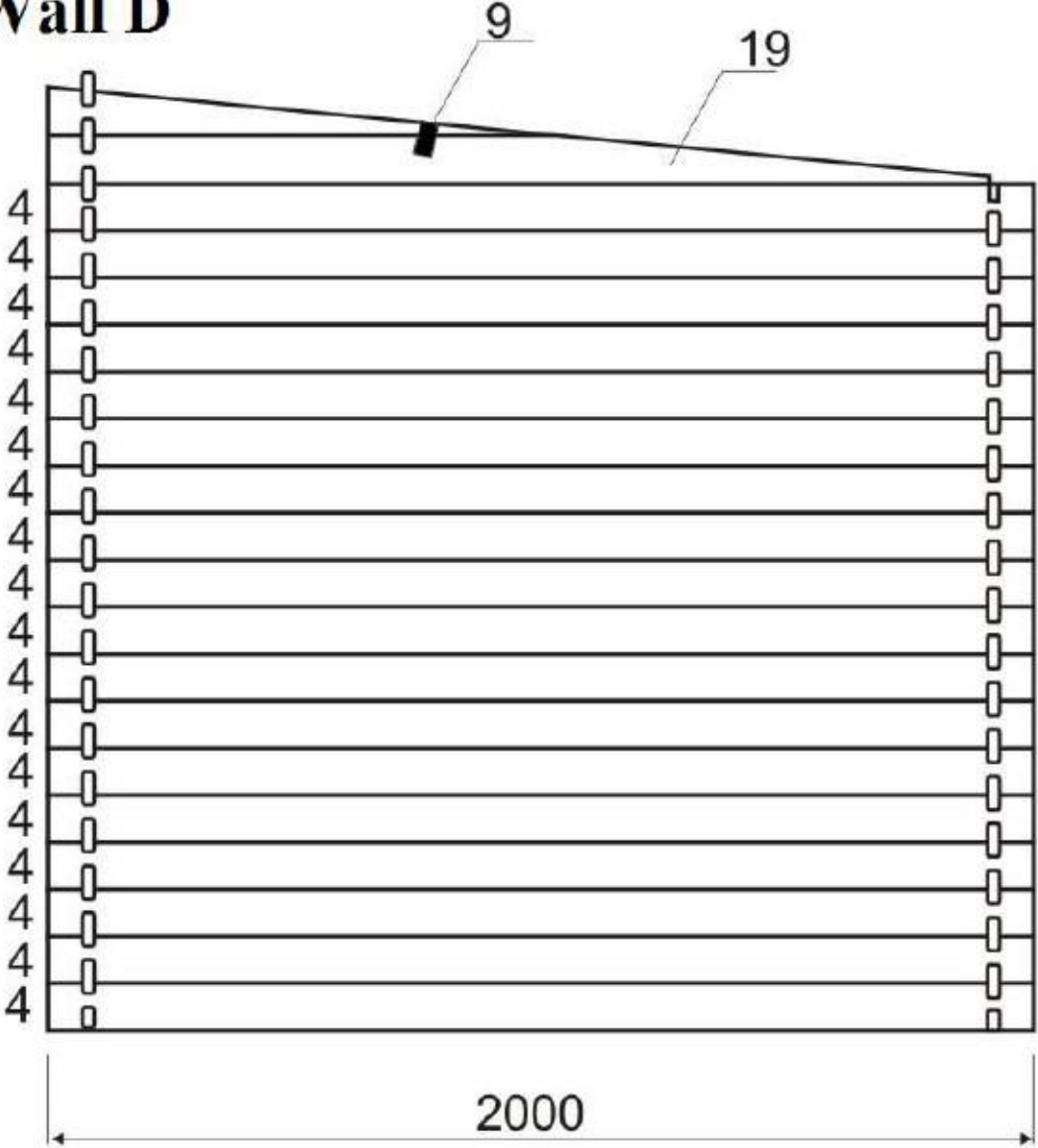

4.5. Roof frame triangles: After the walls are assembled, mount the roof frame triangles. These should be mounted as whole structures.

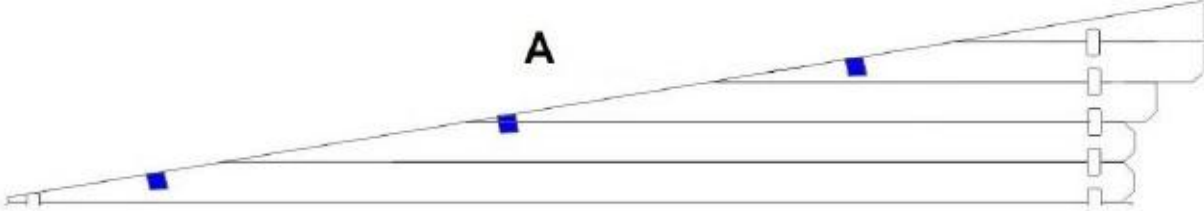

4.6. Rafters: The rafters must be mounted horizontally and inserted in the mounting-spaces found on the roof frame triangles.

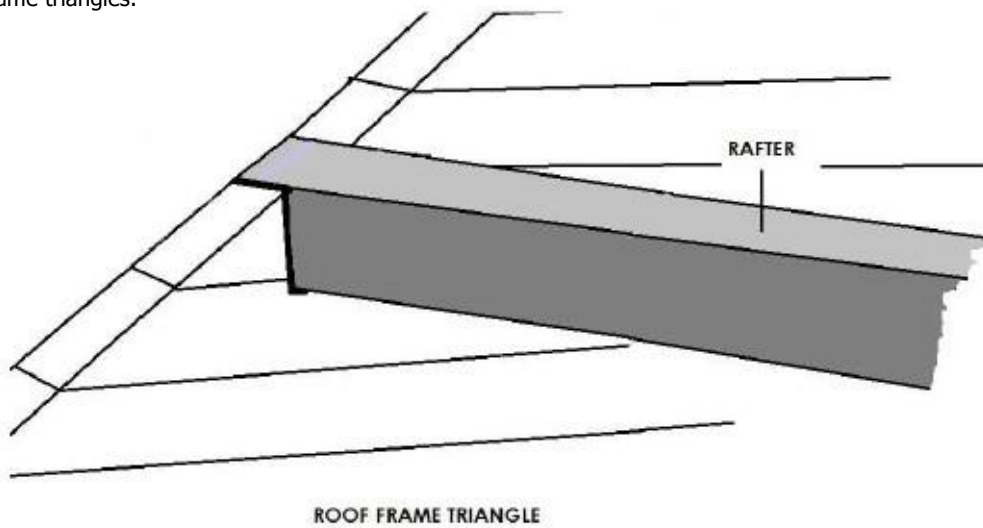

4.7. Roof-boards: The next step is to attach the roof-boards vertically and screw them into the rafters. Make sure the ends of the roof-boards are perfectly parallel to each other. Then fix the roof plank boarder under the roof-boards as show below. The roof-plank must be screwed to the roof plank boarder.

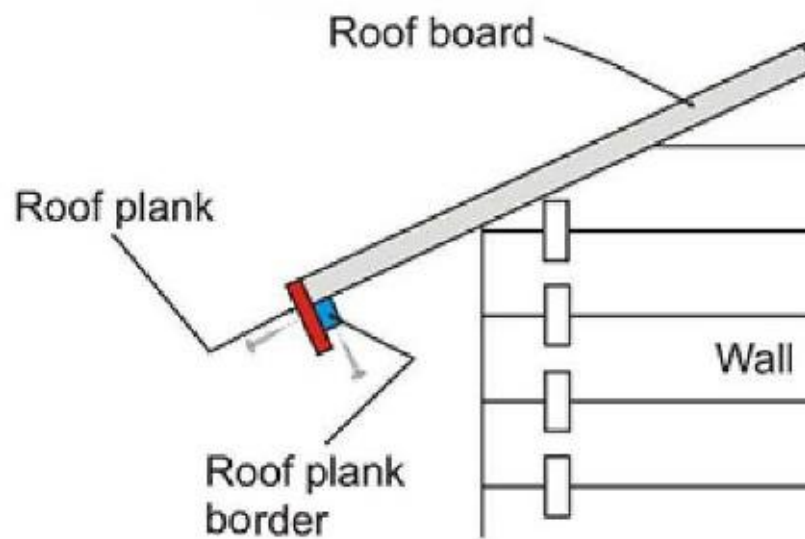

4.8. Wind-boards: Place the wind-board and a wind board supporter on top of each other to make a 90 degree angle. Now attach these ones on a roof frame triangle and fix by screwing them in.

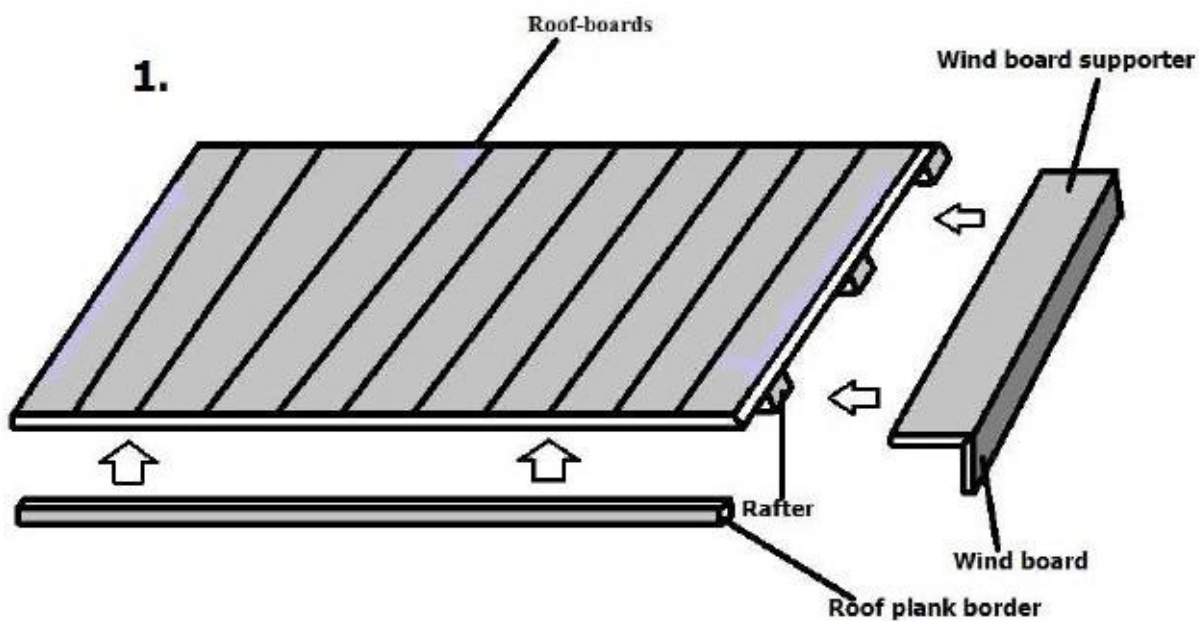

Attach the roof plank border to the roof boards and screw in the roof plank on top.

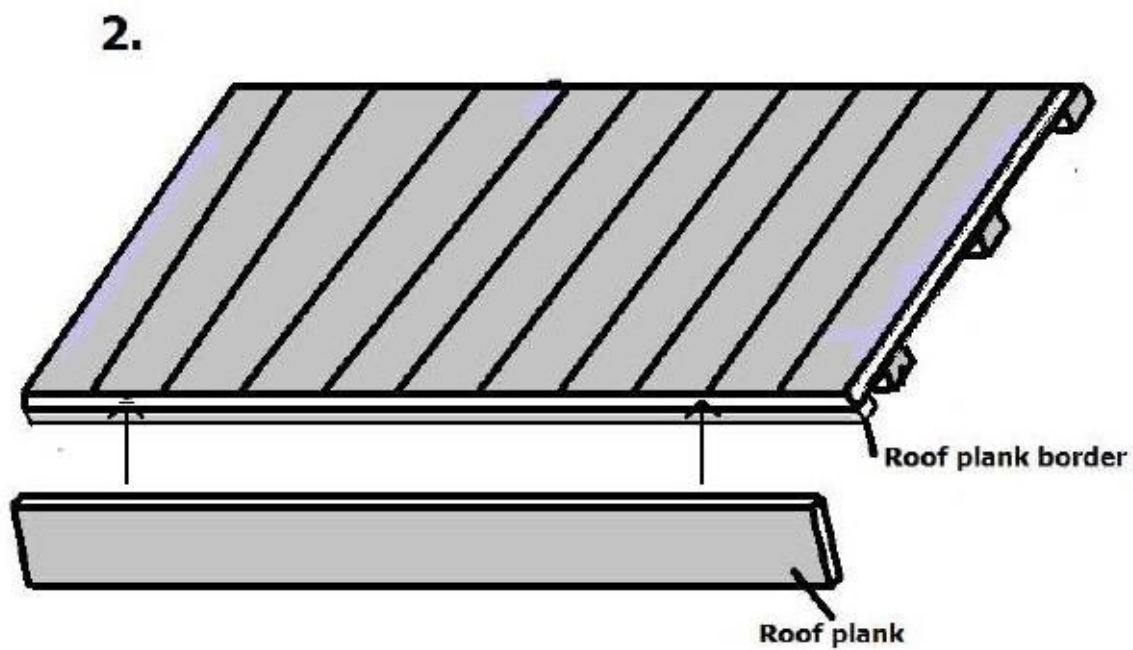

4.9. Door: Screw the support trims in to the door frame:

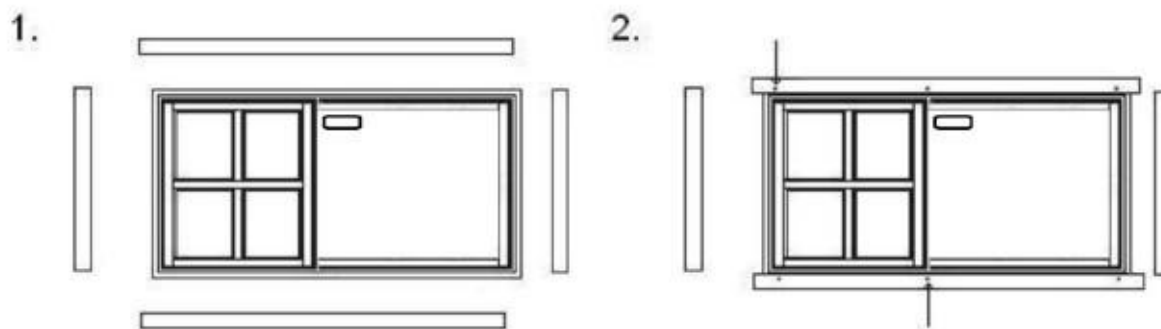

Insert door frame in to its space from the outside of the structure. Then fix the rest of the support trims from inside the building:

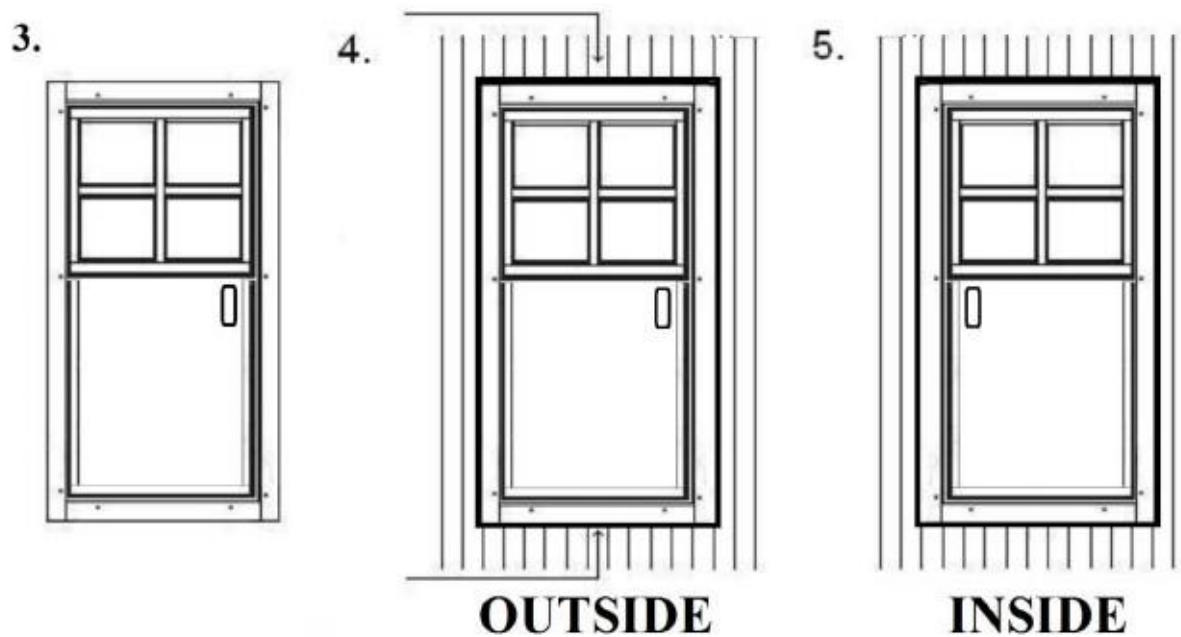

Notice:

- Keep in mind that the support trims must be screwed to the window or door frames, not to the wall-boards!

- Do not worry about the space between the wall and upper window frame. The wood will naturally contract so that the space should disappear within a month or so. Do not try to fill the space in yourself during the assembly process.



4.11. Floor: Place the floor-boards across the bearers and screw them in at an angle. In this way you will have a screw-free clear floor. After the floor-boards are mounted, screw the floor-boards decorative trims in to the floor-boards.

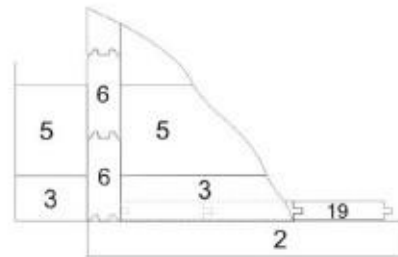
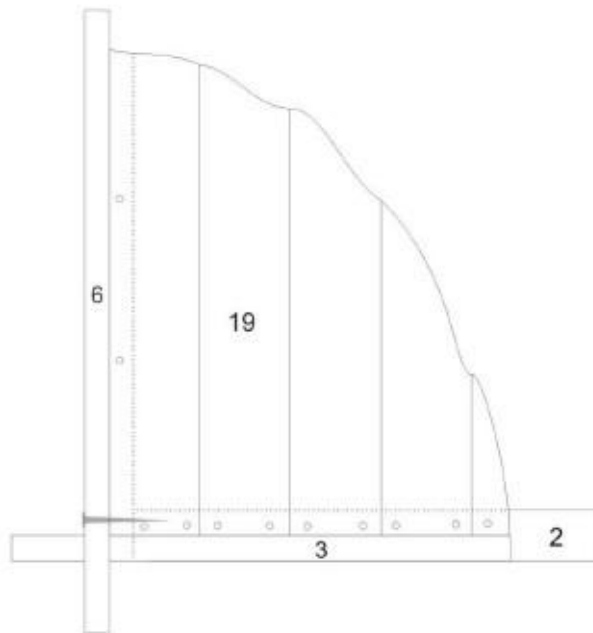

2, - Bearer
19 - Floor-boards
3, 5, 6 - Wall-boards

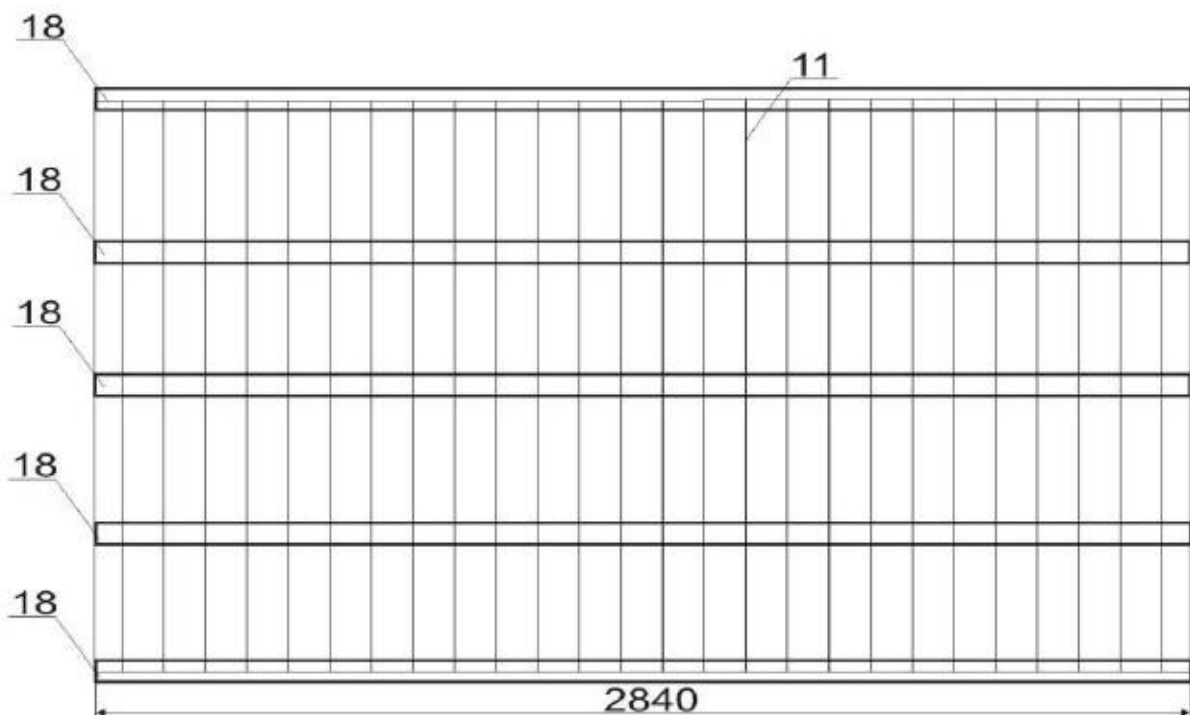

4.12. Felt roof shingles: When the whole structure is assembled and has been treated, attach the felt roof shingles to the roof-boards as shown in the picture. We recommend that you cover the roof only after the structure has been treated.

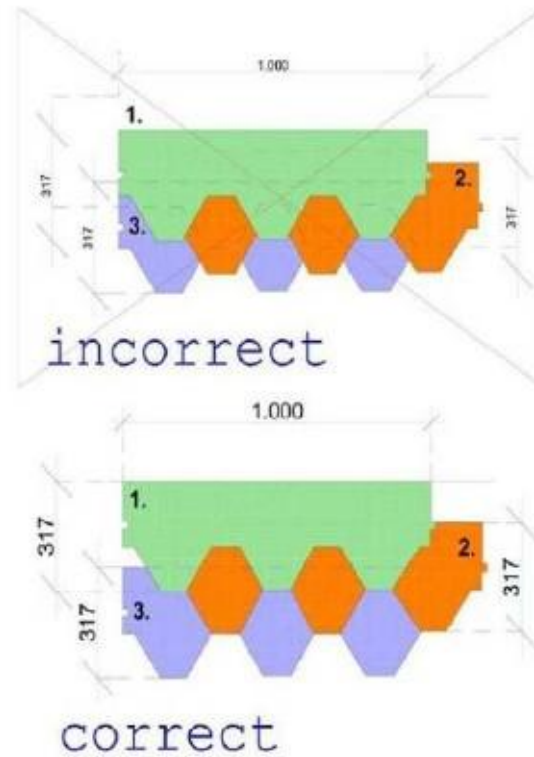

Treatment. It is important to treat the product using a quality wood-preservative instantly after the assembly process is finished. Apply at least 2 coats to the outside and 1 to the inside. Repeat annually.

